

## **AnaSat<sup>®</sup>-C series**

# **AnaSat<sup>®</sup> Transceiver Operating Manual**

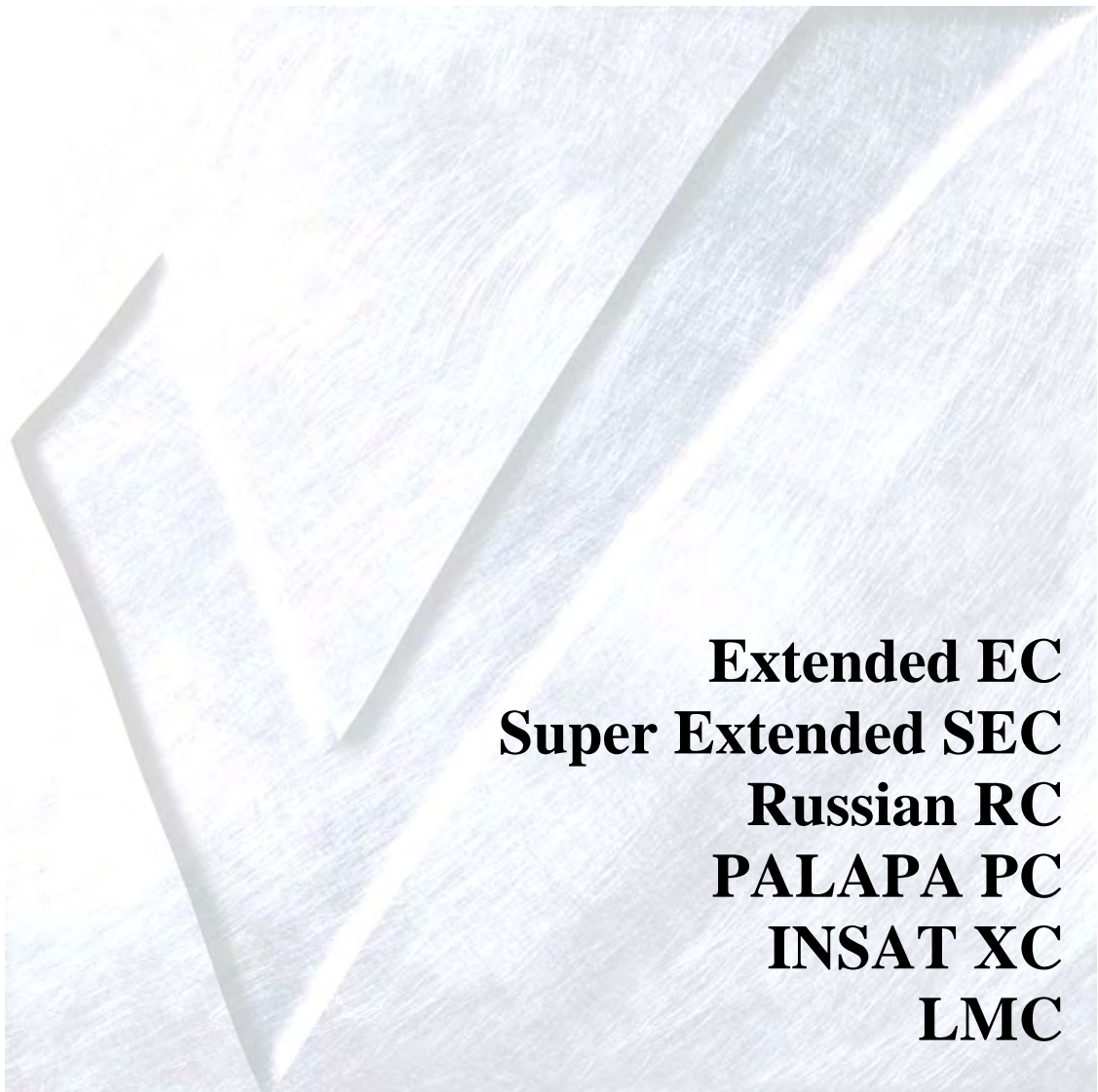

You have just received an AnaSat<sup>®</sup>-C Transceiver, a cost-effective product with no compromise on quality and reliability. This product should provide tireless performance in any reasonable operating environment.

We at AnaCom have taken great care to provide a convenient, easy-to-use product in a single package. Should a situation arise beyond the operator's control, just give us a telephone call. Many situations can be diagnosed and solved by AnaCom's trained customer-service personnel over the phone.

If you have any questions, require technical assistance or training please call AnaCom directly at (408) 519-2062 or FAX to us at (408) 519.2063. You can also send e-mail to techsupport@anacominc.com and one of our engineers will contact you.

---

---

## ANACOM, INC.

1996 Lundy Ave.  
San Jose, CA 95131  
Tel: (408) 519-2062  
Fax: (408) 519-2063

---

*©2011 AnaCom, Inc. All rights reserved. The information furnished by AnaCom, Incorporated, in this publication is believed to be accurate and reliable. However, no responsibility is assumed by AnaCom for its use, nor any infringements of patents or other rights of third parties resulting from its use. No license is granted by implication or otherwise under any patent or patent right of AnaCom, Inc. AnaCom reserves the right to change circuitry and specifications at any time without prior notice.*

*The following terms are trademarks of their respective holders:*

*AnaSat, ELSAT, AnaCom, Inc.*

*Polyswitch*

*Teflon*

*Duroid*

*VT52, VT100 Digital Equipment Corp.*

*INTELSAT*

---

# Operating Manual

for

## AnaSat<sup>®</sup> C-Band Transceivers

---

### Table of Contents

<b>AnaSat<sup>®</sup>-C Quick Start Guide .....</b>	<b>5</b>
<b>Introduction.....</b>	<b>6</b>
<b>Typical Operating Parameters - AnaSat<sup>®</sup> C-Band.....</b>	<b>7</b>
<b>Physical Characteristics - AnaSat<sup>®</sup> C-Band.....</b>	<b>8</b>
<b>Installation.....</b>	<b>9</b>
Unpacking.....	9
Tools and Test Equipment.....	9
Safety Precautions.....	9
General.....	9
Power Supply.....	10
Transceiver.....	10
Power Amplifier.....	10
LNC.....	10
Site Considerations.....	10
Antenna.....	10
Power Requirements.....	11
Transceiver Mounting Considerations.....	11
Transceiver Mounting.....	11
Grounding.....	11
LNC/TR Filter Mounting.....	14
Cable and Waveguide Connections.....	14
Cabling Requirements.....	14
1. Transmitter Feed.....	14
2. 70MHz Modem.....	14
3. AC Power.....	15
4. LNC.....	15
5. Terminal Connections.....	15
Final Check.....	16
Water Resistance Wrap.....	16
<b>Operation.....</b>	<b>18</b>
Preliminary Steps.....	18
Terminal Connection and Configuration.....	18
Autolink.....	18
Frequency Programming.....	18
TXC; RXC.....	18
TXF; RXF.....	18

---

Antenna Adjustment .....	20
M & C Operation .....	20
Terminal Display .....	20
Gain Adjustments.....	22
Transmitter Gain .....	22
Receiver Gain.....	22
Basic M & C Commands .....	23
<b>Maintenance .....</b>	<b>24</b>
LNC Replacement.....	24
LNC Replacement Procedure .....	24
Checking Receive Gain.....	24
Fan Replacement.....	25
<b>Alarm Relay Closure Option .....</b>	<b>26</b>
Monitored Values.....	26
18-Pin Circular Weathertight Connector .....	26
<b>Appendix A. M &amp; C Command Set.....</b>	<b>27</b>
Alphabetical Listing of M & C Commands .....	27
<b>Appendix B. ARM9 M&amp;C Card Connection Methods .....</b>	<b>34</b>
Serial Port Methods.....	34
RS-232 .....	34
RS-485 .....	34
FSK .....	34
Ethernet-based Methods.....	35
Supervisor 10 .....	36
Telnet .....	37
HTTP (web browser) .....	38
SNMP.....	39
<b>Appendix C. Serial Port Wiring .....</b>	<b>40</b>
COM1, 6-Pin Circular Weathertight Connector .....	40
COM0, 18-Pin Circular Weathertight Connector .....	40
RS485/RS232 Selection.....	41
Data Terminal Connection.....	41
Alternative Alarm Relay Wiring.....	41
<b>Appendix D. Satellite Channel Listings .....</b>	<b>42</b>
<b>Appendix E. dBm/Watts Conversions.....</b>	<b>43</b>
<b>LIMITED WARRANTY .....</b>	<b>44</b>

---

# AnaSat<sup>®</sup>-C Quick Start Guide

1. Mount the transceiver and the LNC on the antenna.
2. Connect the cables as shown in the drawing (See page 16 of Operations Manual).
3. Connect a terminal to a serial port, configured to 1200bps, 8 data bits, no parity, 1 stop bit, CR/LF Off. Connection diagrams are in Appendix C.
4. Install a proper power connector on the (included) power cable. Plug the cable into 110 or 240VAC, 50/60Hz. Verify the green LED on the transceiver is blinking, indicating normal internal operation. The red LED is usually OFF. If illuminated, it indicates an alarm condition requiring attention. Refer to the ALARM command for details (Appendix A).

5. Using the terminal, configure the transceiver to the proper frequency:

RXFREQ    nnnn            (nnnn in MHz —see Appendix D for channel)

TXFREQ    nnnn            (nnnn in MHz —see Appendix D for channel)

6. Configure receive gain and transmit output power:

RXGAIN    nnn    nnn ranges from            85 to 100

TXGAIN	nn	nn ranges from:	10 to 36 [0C]	44 to 70 [2C]
			48 to 74 [5C]	51 to 77 [10C]
			54 to 80 [20C]	57 to 83 [30C, 40C]
			58 to 84 [50C, 60C]	60 to 86 [70C, 80C]
			61 to 87 [100C]	62 to 88 [125C]
			63 to 89 [150C]	64 to 90 [180C]
				64 to 90 [200C]

7. Enable the Transmitter:

TX ON    (TX OFF takes the transmitter OFF air)

## Introduction

The AnaSat<sup>®</sup>-C VSAT series C-Band transceivers are designed for continuous outdoor duty in all types of environments. Ideally suited for SCPC, MCPC, and DAMA applications, the AnaSat<sup>®</sup>-C series transceivers transmit in the 6 GHz frequency range and receive in the 4 GHz range.

The AnaSat<sup>®</sup>-C VSAT transceiver integrates all necessary functions, including the solid-state power amplifier (PA), into a small, highly integrated outdoor package. The only cabling required to the indoor plant are the IF and AC power cables. The LNC connects to the transceiver with a single coaxial cable.

Designed to interface with any 70 MHz modem, the AnaSat<sup>®</sup>-C VSAT transceiver may be used in a wide variety of communication networks. The earth stations may be configured in Star, Mesh, or Ring networks and with the optional Station Management System (SMS) tied to a PC, you can monitor and control all local transceivers and other network-compatible equipment.

The AnaSat<sup>®</sup>-C transceiver upconverts the modulator's 70 MHz IF output to an RF signal in the 6 GHz range for transmission, and downconverts the 4 GHz received RF signal to a 70 MHz IF signal for use by the demodulator.

The PA uses Internally-Matched Field-Effect Transistors (IMFET) to achieve highly linear power and gain with minimal intermodulation distortion (IMD) products.

High Electron Mobility Transistors (HEMT) and Gallium-Arsenide Field-Effect Transistors (GaAs FET) enable the Low-Noise Down-Converter (LNC) to achieve a noise figure better than 35 °K.

The transmit (TX) and receive (RX) synthesizers are locked to an oven controlled, high-stability crystal oscillator (OCXO) and can provide 1 MHz frequency selection step sizes over the entire bandwidth. TX and RX frequency selection is completely independent for extra flexibility.

In this manual, all frequency ranges reflect the Standard "C" model of the AnaSat<sup>®</sup>-C transceiver except as noted.



Figure 1 - 5W AnaSat<sup>®</sup>-C VSAT transceiver



Figure 2 - 100W AnaSat<sup>®</sup>-C VSAT transceiver

## Typical Operating Parameters - AnaSat<sup>®</sup> C-Band

Unit Power	0W	2W	5W	10W	20W	30W	40W	50W	60W
1 dB Compression Point	8	33	37	40	43	44.8	46	47	47.8
TX Gain	31	64	68	71	74	75.8	77	78	78.8

Unit Power	70W	80W	100W	125W	150W	180W	200W	300W	350W	400W
1 dB Compression Point	48.5	49	50	51	51.8	52.6	53	54.8	55.4	56
TX Gain	79.5	80	81	82	82.8	83.6	84	85.8	86.4	87

<b>TX Gain Range</b>	+6/-20 dB variable in 1 dB steps via M&C		
<b>TX Level Flatness</b>	± 1.5 dBp -p max / 500MHz		
<b>TX Gain Over Temperature</b>	± 1.5 dB max		
<b>TX Input IF Frequency</b>	52 to 88 MHz		
<b>TX Input IF Impedance</b>	50 ohms (75 ohms optional)		
<b>TX Input IF Level</b>	-30 dBm for rated output with nominal gain		
<b>TX Output Frequency</b>	EC = 5.850 to 6.425 GHz	SEC = 5.850 to 6.725 GHz	PC = 6.425 to 6.725 GHz
	RC = 5.975 to 6.475 GHz	XC = 6.725 to 7.025 GHz	
<b>TX Frequency Step Size</b>	1 MHz (XC Band 500 KHz step size)		
<b>TX Phase Noise</b>	-60 dBc/Hz max @ 100Hz	-70 dBc/Hz max @ 1KHz	
	-80 dBc/Hz max @ 10KHz	-90 dBc/Hz max @ 100KHz	
<b>Intermod</b>	-33 dBc max (2 carriers, each 9dB back off from P1dB rating)		
<b>Spurious</b>	-65 dBc max out of band		
<b>RX Input Frequency</b>	EC = 3.625 to 4.200 GHz	SEC = 3.400 to 4.200 GHz	PC = 3.400 to 3.640 GHz
	RC = 3.650 to 4.150 GHz	XC = 4.500 to 4.800 GHz	
<b>RX Frequency Step Size</b>	1 MHz (XC Band 500 KHz step size)		
<b>RX Output Frequency</b>	52 to 88 MHz		
<b>RX Gain</b>	75 to 100 dB M&C controlled		
<b>RX Noise Figure</b>	0.9 dB (65K) MAX / Optional 0.63 dB (45K) and 0.49 dB (35K)		
<b>RX Linearity</b>	-35 dBc intermod, MAX		
<b>RX Phase Noise</b>	-60 dBc/Hz max @ 100Hz	-70 dBc/Hz max @ 1KHz	-80 dBc/Hz max @ 10KHz
	-90 dBc/Hz max @ 100KHz	-100 dBc/Hz max @ 1MHz	
<b>RX Output Impedance</b>	50 ohms (75 ohms optional)		
<b>Alarm Relays</b>	FORM C for Summary Alarm; Isolated		
<b>Power</b>	100 to 250 VAC; 47 to 63 Hz		optional 48V DC
<b>M&amp;C</b>	SNMP, HTTP, Telnet		Ethernet, RS-232, RS-485, FSK
<b>Temperature</b>	-50 to +55°C operational		-50 to +75°C storage
<b>Humidity</b>	95% at 45C		
<b>Altitude</b>	6500 meters (21,325 ft)		
<b>Rain</b>	20 inches per hour		
<b>Wind</b>	150 miles per hour		
<b>Vibration</b>	1.0 g random operational, 2.5 g random survival		
<b>Shock</b>	10 g operational, 40 g survival		

## Physical Characteristics - AnaSat<sup>®</sup> C-Band

Unit Power	0W	2W	5W	10W	20W	30W	40W	50W	60W
<b>Typical Power Consumption</b>	41	73	83	125	229	280	390	394	398
<b>Prime Power Recommendation</b>	100	150	220	340	600	730	870	880	890
<b>Weight (lbs.)</b>	23	27	29	34	40	43	45	57	57
	(kg.)	10	12	13	15	18	20	20	26

Unit Power	70W	80W	100W	125W	150W	180W	200W	300W	350W	400W
<b>Typical Power Consumption</b>	570	572	762	1179	1179	1539	1539	2832	2832	2832
<b>Prime Power Recommendation</b>	1200	1200	1600	2400	2400	3100	3100	6200	6200	6200
<b>Weight (lbs.)</b>	67	67	67	135	164	164	164	260	260	260
	(kg.)	30	30	30	61	74	74	74	118	118

### Dimensions:

<b>0W</b>	21.6" x 9.0" x 6" 549 x 229 x 152 mm	<b>20W 30W</b>	21.6" x 9.0" x 10.3" 549 x 229 x 262 mm	<b>70W 80W 100W</b>	21.6" x 13" x 11.2" 549 x 330 x 284 mm
<b>2W 5W</b>	21.6" x 9.0" x 7" 549 x 229 x 177 mm	<b>40W</b>	21.6" x 9.0" x 11.4" 549 x 229 x 289 mm	<b>125W 150W 180W 200W</b>	34.5" x 12.75" x 12.4" 876 x 324 x 315 mm
<b>10W</b>	21.6" x 9.0" x 9.4" 549 x 229 x 238 mm	<b>50W 60W</b>	21.6" x 9.0" x 12.5" 549 x 229 x 317 mm	<b>300W 350W 400W</b>	34.5" x 25.5" x 12.36" 876 x 648 x 314 mm



## Installation

The AnaSat®-C transceiver package consists of the transceiver, the Low Noise Converter (LNC), and the LNC interconnection cable.

This chapter contains the general requirements for installing the transceiver and LNC on the antenna and making the cable and waveguide connections. Specific mounting methods may vary considerably depending upon particular antenna and site characteristics. Refer to the antenna manufacturer's instructions for more detailed instructions.

AnaSat®-C transceivers are designed for installation and setup without removing the cover. The transceiver may be completely initialized for normal operation using an ASCII terminal or a local computer.



*Removal of any cover may jeopardize the weather seal, which may cause problems later.*

## Unpacking

Check to make sure that the Transceiver has not suffered any damage in shipment. Compare contents of the crate to ensure items received match those listed on the packing slip. Retain all shipping containers for future use.

## Tools and Test Equipment

Have on-hand a standard electrician's tool kit and any tools listed in your antenna installation instructions.

## Safety Precautions

### General



*Observe normal safety precautions when operating this equipment.*

Ensure the AnaSat®-C transceiver and LNC are properly grounded. Do not rely on coaxial cable shields for the ground connection. If the cover is removed from any AnaCom product, ensure that all:

- gaskets are intact and free of damage prior to reinstallation
- mounting screws are properly installed

Ensure all connectors are properly waterproofed.

## ***Power Supply***

Confirm that AC Power is disconnected before removing the transceiver or LNC cover.

## ***Transceiver***

Take adequate precautions to ensure the AnaSat®-C transceiver does not transmit a signal until it has been properly connected and set up for authorized frequencies and power levels. The transmitter is normally shipped from the factory with TX ON!



*Transmitter RF output power levels are adequate to cause blindness or other serious injury to body tissues. Use caution when working around the Transceiver or antenna when the system is active.*

## ***Power Amplifier***

Be sure the transceiver TX OUT port is properly terminated prior to operation. Ensure all the correct waveguide gaskets are used to prevent water damage.

**TO ENSURE PROTECTION OF PERSONNEL AND EQUIPMENT, USE CARE DURING ANTENNA INSTALLATION AND WHENEVER WORKING ON OR AROUND THE SYSTEM.**

## ***LNC***

Be sure the LNC unit is properly terminated prior to operation. Ensure all the correct waveguide gaskets are used to prevent water damage.

## **Site Considerations**

The installation requirements of any particular site are the responsibility of the system operator. AnaCom offers an optional installation mounting kit, that can be used at most sites. Contact AnaCom for details.

## ***Antenna***

The transceiver must be attached to some form of mounting structure which is usually the antenna feed boom or the antenna bracket structure. Specific mounting procedures will depend on the antenna used. The transceiver and LNC are designed to be mounted on most antennas. Locate and install the antenna according to the antenna manufacturer's instructions. Choose an area that is free of extraneous interference from motors and electronic equipment and has a clear line-of-sight from the antenna to the satellite.

Lightning arrestors should be used at the site to protect personnel and equipment. Size 3/0 or 4/0 stranded copper wire should be used to bond the transceiver to the antenna frame and to the lightning protection ground rod.

## Power Requirements

The AnaSat®-C transceiver requires a power source that supplies 110 VAC or 220 VAC at 50 or 60 Hz, through a circuit breaker. Specific circuit breaker size will depend on which transceiver is being used. To assure uninterrupted service, some method of backup AC power is recommended. Installing surge arrestors and AC power line filters will reduce voltage surges from the AC power input. .

NOTE: AC TRANSIENTS AND SURGES MAY CAUSE DATA TRANSMISSION ERRORS AND LOSS OF SYNCHRONIZATION IN THE TRANSCEIVER SYNTHESIZERS AND/OR THE EXTERNAL MODEM EQUIPMENT.

## Transceiver Mounting Considerations

The AnaSat®-C transceiver must be mounted such that:

1. Sufficient support is afforded the transceiver to minimize the effects of antenna sway in strong winds.
2. Air movement is possible across the heat sink fins. Ideally, the fins should be aligned vertically, but this is not required.

NOTE: The length (and associated RF losses) of the interconnecting cables must be considered when determining the location of the transceiver and LNC.

## Transceiver Mounting

The AnaSat®-C transceiver is designed for mounting in any position. For optimal heat sink action, the heat sink fins should be vertical, or as nearly vertical as is practical. Figure 2-1 shows a common installation example where the transceiver is mounted on the antenna feed support arm.

When mounting the transceiver, allow enough room to adjust the antenna's azimuth and elevation. Throughout installation and during any polarization, azimuth, or elevation adjustment, ensure the power cables, IF cables, and any waveguide parts are not crimped or pinched.

## Grounding

Electrical bonding (grounding) of the transceiver is required to prevent possible damage from lightning or other induced electrical surges.

The transceiver is provided with both an M3, and a #6 grounding point. It is recommended that heavy gauge copper wire or copper braid be used to bond this unit to the earth ground (grounding rod) using the most direct (shortest) route possible.

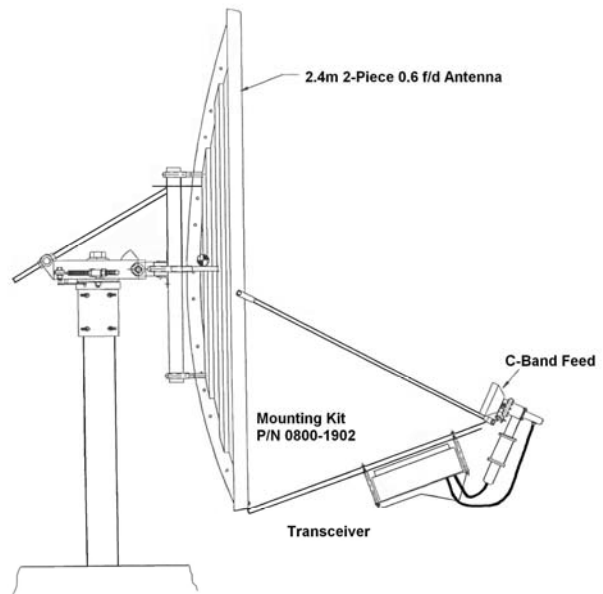

Figure 2-1. Typical Transceiver mounting

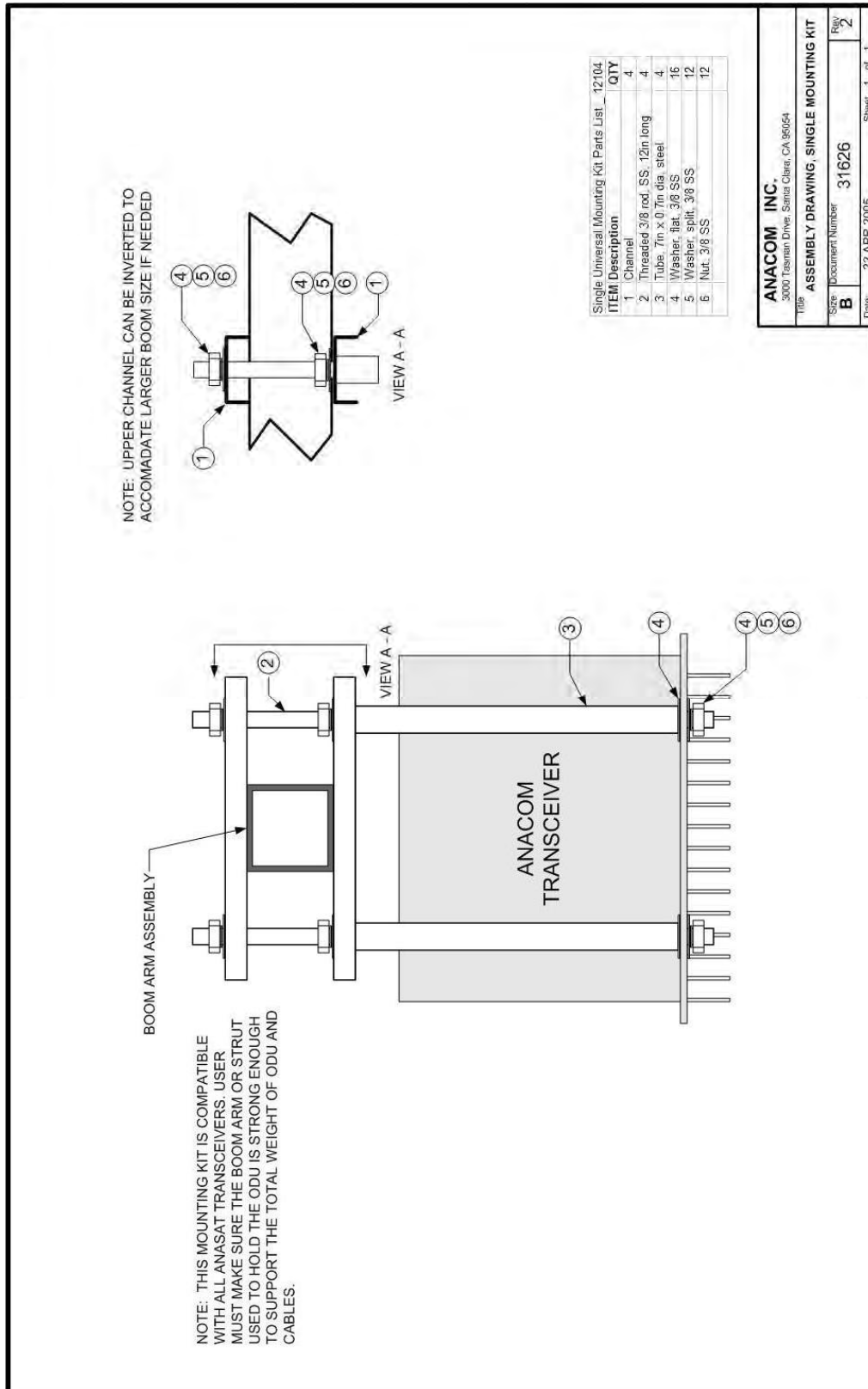
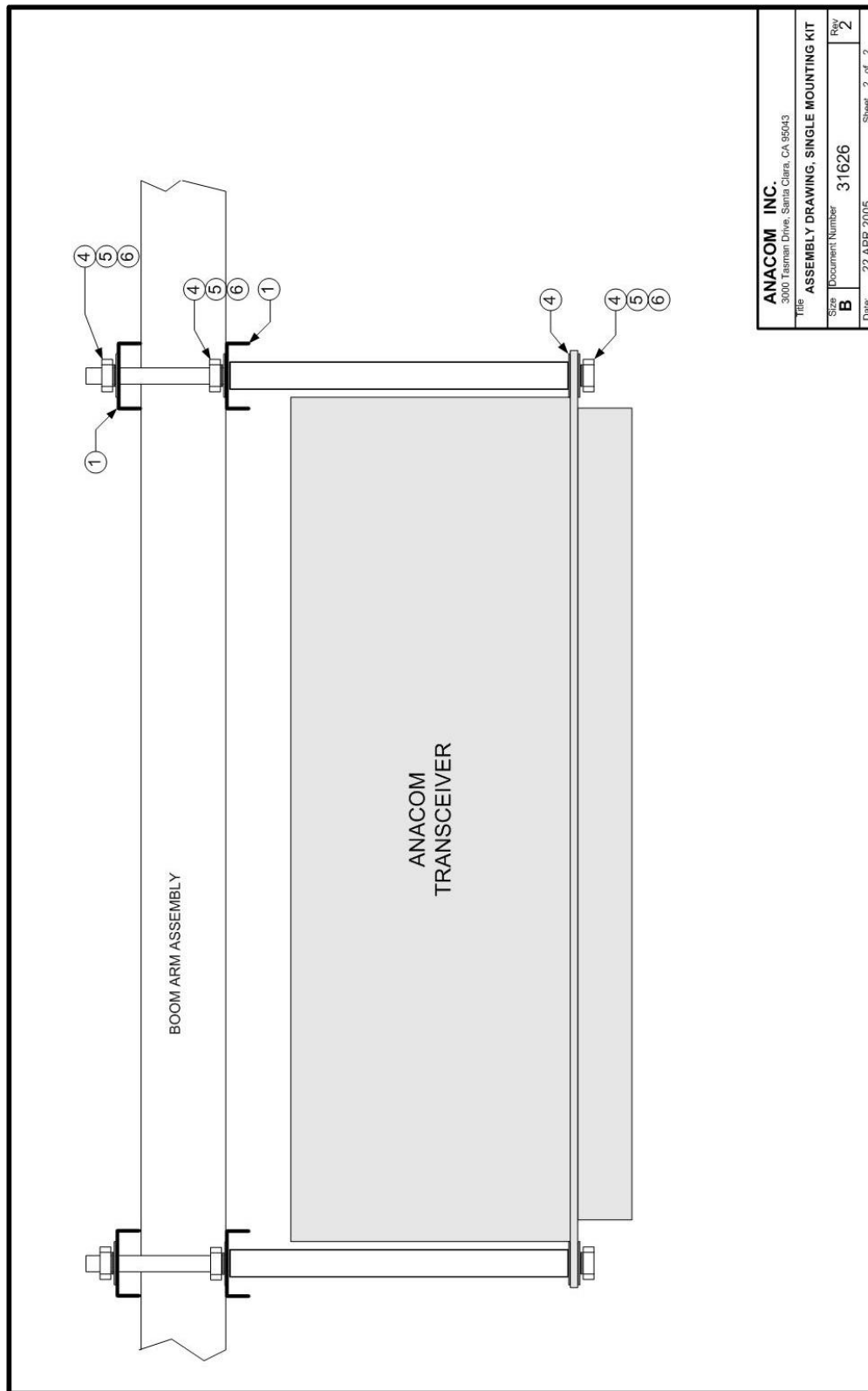

Figure 2-1a Transceiver Mounting for Single Thread



<b>ANACOM INC.</b>	
3000 Tannan Drive, Santa Clara, CA 95043	
Title: <b>ASSEMBLY DRAWING, SINGLE MOUNTING KIT</b>	
Size: <b>B</b>	Document Number: <b>31626</b>
Rev: <b>2</b>	Date: <b>22 APR 2005</b>
Sheet: 2 of 2	

Figure 2-1b Transceiver Mounting for Single Thread

### ***LNC/TR Filter Mounting***

The LNC is shown in Figure 2-2. Normally the LNC is directly bolted to the antenna RX feed. In some situations, additional transmit-to-receive isolation may be required to achieve true low-noise receive operation. In that case, the optional TR filter (Figure 4-3) should be bolted between the LNC and the antenna receive port. An appropriate waveguide gasket must be included at both ends of the TR filter. Connect one end of the coaxial cable with male N-connectors (included) to the LNC. Refer to the note at the end of this section regarding watertight connections. Route the 10-foot cable to the transceiver and connect to the LNC N-connector. Longer or shorter cable lengths may be used; contact ANACOM for details.



Figure 2-2. LNC assembly.

**Caution:** Never touch the ground-plane antenna pin found inside the wave-guide flange of the LNC. The front-end preamp is susceptible to static discharge.

## **Cable and Waveguide Connections**

### ***Cabling Requirements***

Local regulations may require that cables in occupied buildings be installed in steel conduit. Local government agencies may waive this requirement for the use of Plenum cables, which are standard cables entirely encased in solid Teflon. Check the codes in your area.

NOTE: EQUIPMENT OUTAGES DUE TO FAULTY CABLE MATERIALS OR INSTALLATION ARE NOT COVERED BY YOUR WARRANTY.

Figure 2-4 provides the cabling diagram for the AnaSat<sup>®</sup>-C transceiver.

#### **1. Transmitter Feed**

Connect a section of low loss cable with a type N connector between the OMT transmit port and the transceiver's transmit output, TX OUT. Ensure the connections are weather-tight. For transceivers with the CPR-137 flange option, connect a section of flexible CPR-137G waveguide between the antenna OMT transmit port and the transceiver's transmit output, TX OUT. (Waveguide should be attached to the antenna feed per manufacturer's instructions). Ensure a gasket is fitted at each flange.

#### **2. 70MHz Modem**

Attach a coaxial cable with male N-connectors between the transceiver's TX IF and the modulator IF OUTPUT. Make sure that the connections are weather-tight.

Attach a coaxial cable with male N-connectors between the transceiver's RX IF and the demodulator IF INPUT. Make sure that the connections are weather-tight.

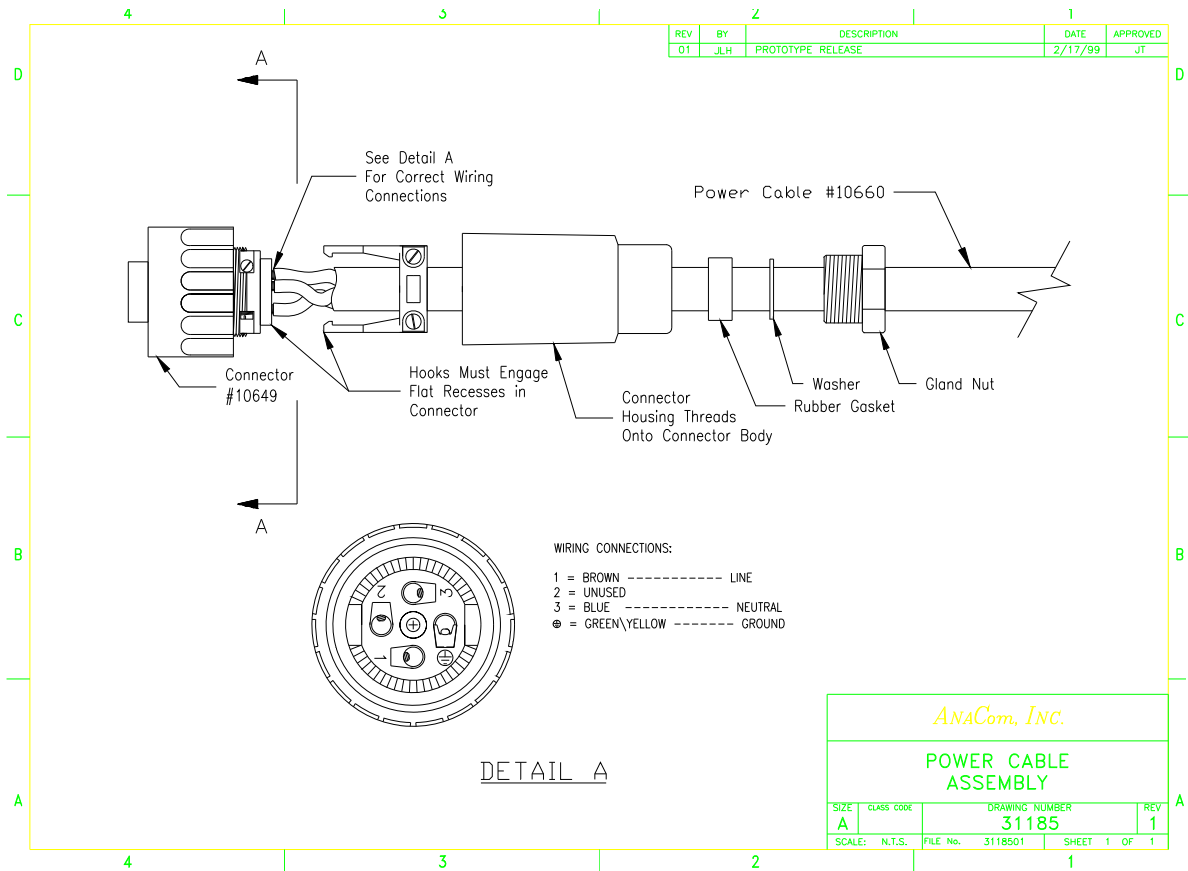

### 3. AC Power

Attach the AC input cable to the 4-pin connector on the transceiver. Run the AC cable to the power source *but do not attach yet*. The supplied power cable has a weather-tight circular connector attached to one end. The other end is terminated with flying leads. Attach the proper AC power connector for your location to the end of this cable.

**Color Code:**

- Brown**..... AC Hot power lead
- Blue** ..... AC Neutral power lead
- Green/Yellow**.... Ground

### 4. LNC

Attach the RF cable between the LNC connector and the transceiver LNC input connector. If a longer cable is required, insure that the replacement cable is designed for low loss at microwave frequencies. Maximum loss of the LNC cable must be 5 dB or less at 5 GHz!

### 5. Terminal Connections

A data terminal or a computer with terminal software connects to the AnaSat<sup>®</sup>-C via either RS-232 or RS-485 serial ports. Appendix C shows the pinout of the serial outputs. Both 6-pin and 18-pin weather-tight circular connectors are included. An optional serial computer cable is available from ANACOM.

## ***Final Check***

Recheck all bolts and cabling. Refer to Figure 2-4 to verify cable connections.

*After all other connections have been made, connect the AC power cord to an active outlet.*

## ***Water Resistance Wrap***

The application of moisture-resistant wrap (*mastic tape*) to all connectors is recommended to prevent water entry and resultant water damage. See Figure 2-3. Apply the mastic tape as follows:

1. Ensure that all connectors are tight.
2. Pre-cut the mastic tape to the desired size.
3. Center the tape on the connector to be sealed and wrap the tape tightly around the connector. Squeeze the tape tightly and ensure that both ends of the tape have formed around the connector and the cable.
4. Apply the mastic tape to all connectors that may be exposed to moisture.

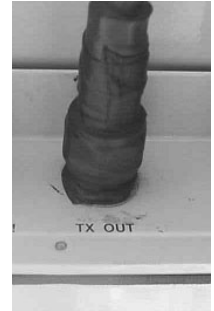

*Figure 2-3.  
Mastic Tape  
Application*



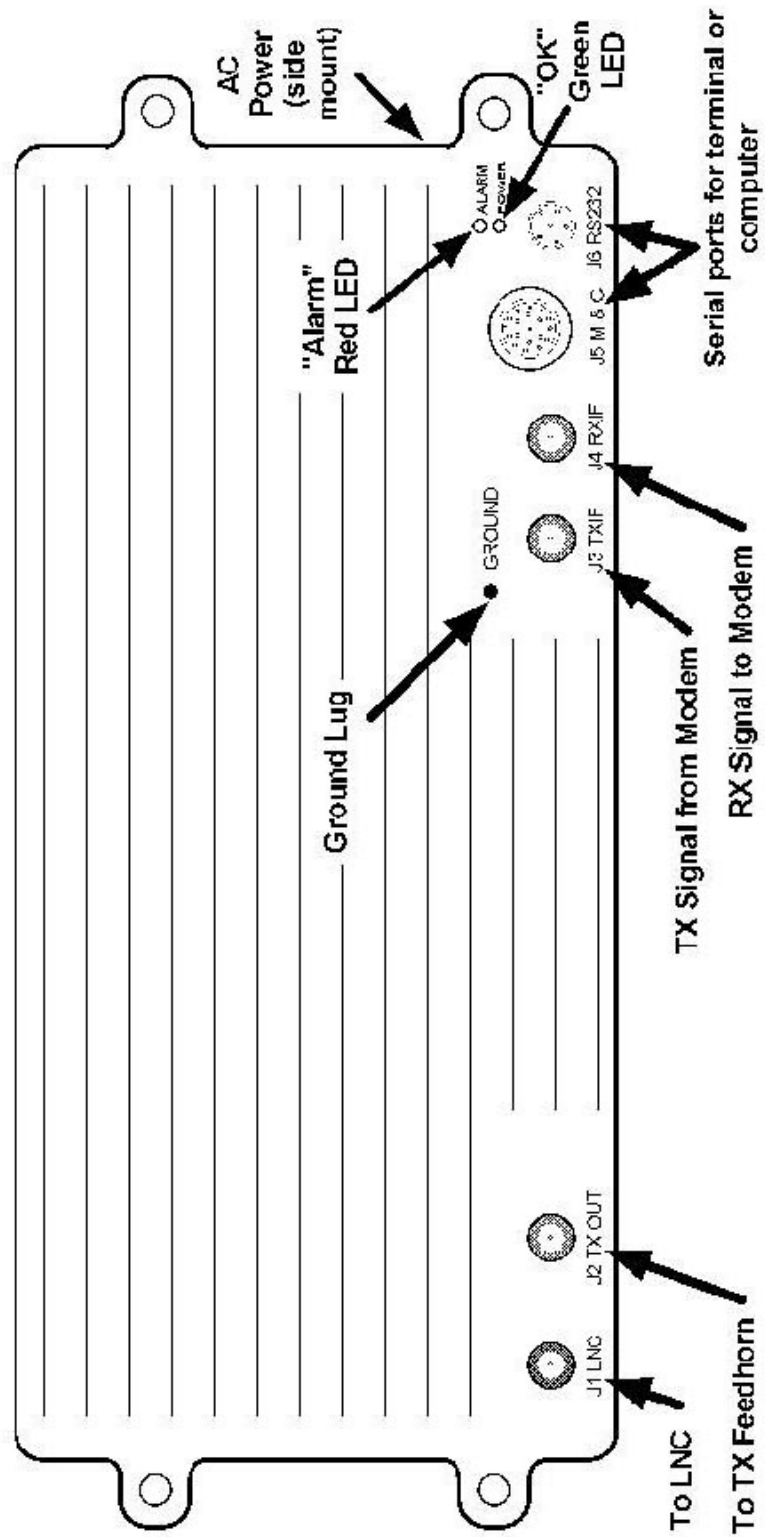

Fig 2-4. Transceiver Cabling Diagram

# Operation

## Preliminary Steps

After the AnaSat<sup>®</sup>-C hardware is mounted and verified, the antenna must be aimed toward the desired satellite. Follow the antenna/mount manufacturer's instructions, using coordinates provided by the satellite operator. *Do not transmit until you have received authorization from the satellite network operation center, and a transmit power level from its engineering staff.*



*AnaCom Transceivers are shipped from the factory with TX ON as active.*

## *Terminal Connection and Configuration*

### *Autolink*

The AnaCom M&C features automatic baudrate sensing on the serial ports. If a wrong baudrate is detected, the M&C will drop to 1200 baud and wait for user to move to 1200 baud. AnaCom provides a CD with both our Supervisor and Supervisor Jr. software on it that will establish a link with the ODU automatically, regardless of the last used settings.

Connect a terminal or computer running terminal emulation software to either serial port. Generally, COM 1 (the 6-pin circular connector) is used for on-site maintenance and control. COM 0 is often used in its RS-485 mode, with multi-unit, packetized protocol and differential mode signals good for moderately long distance (up to 4000 feet or 1200m) remote control. Either port or either serial protocol can be used to accomplish setup. Set the terminal to 1200 baud, eight data bits, no parity, and one stop bit (1200,N,8,1 protocol). Refer to Appendix C for wiring diagrams for the COM ports.

## *Frequency Programming*

### *TXC; RXC*

The transmit and receive frequencies are set independently using the TXCHAN (TXC) and RXCHAN (RXC) commands. Refer to Appendix D for calculations of channel numbers versus frequency. NOTE: Appendix D assumes an IF of 70 MHz for both TX IN and RX OUT. Add or subtract any difference between the actual IF and 70 MHz to determine the exact RF frequency employed.

### *TXF; RXF*

Direct frequency entry in MHz can also be done by typing TXF\*\*\*\*\* or RXF\*\*\*\*\* where \*\*\*\*\* are the transceiver frequencies desired. This also assumes exactly 70MHz (or 140 MHz) TXIF & RXIF.

Operating frequencies for standard C-band channels (EC and SEC) are calculated with the following formulas (see next page):

$$f_{TX} = TX\ IF_{IN} + 5854 + Ch\# \quad \text{MHz}$$

$$f_{RX} = RX\ IF_{OUT} + 3629 + Ch\# \quad \text{MHz}$$

For negative channels:

$$f_{TX} = TX\ IF_{IN} + 5855 + Ch\# \quad \text{MHz}$$

$$f_{RX} = RX\ IF_{OUT} + 3630 + Ch\# \quad \text{MHz}$$

For example, if the following commands are given to the transceiver:

```
RXCHAN 50
```

```
TXCHAN 50
```

Then with a TX IN intermediate frequency of 72.5 MHz the result is an output frequency of 5976.5 MHz. Likewise, with an RX OUT IF of 67.5 MHz, then the received RF frequency is 3746.5 MHz.

For XC (INSAT) frequencies, the formulas are:

$$f_{TX} = TX\ IF_{IN} + (13259 + Ch\#) / 2 \quad \text{MHz}$$

$$f_{RX} = RX\ IF_{OUT} + (8859 + Ch\#) / 2 \quad \text{MHz}$$

*NOTE: XC CHANNEL SPACING (STEP SIZE) IS 0.5 MHZ.*

For RC (Russian) frequencies, the formulas are:

$$f_{TX} = TX\ IF_{IN} + 5904 + Ch\# \quad \text{MHz}$$

$$f_{RX} = RX\ IF_{OUT} + 3579 + Ch\# \quad \text{MHz}$$

For PC (PALAPA) frequencies, the formulas are:

$$f_{TX} = TX\ IF_{IN} + 6354 + Ch\# \quad \text{MHz}$$

$$f_{RX} = RX\ IF_{OUT} + 3329 + Ch\# \quad \text{MHz}$$

Both  $f_{TX}$  and  $f_{RX}$  may be directly entered and displayed via the M & C by using the TXFREQ and RXFREQ commands. These commands will change the terminal display from channel number to RF frequency. These frequencies assume exactly 70 MHz IF.

## Antenna Adjustment



*Do not transmit while adjusting the antenna position.*

Follow the antenna manufacturer's instructions for antenna position adjustment. For final alignment, contact the satellite operator and get the correct polarization, azimuth, and elevation of the satellite and also confirm the desired transponder is operational.

Apply power to the AnaSat®-C. While the transceiver requires about 5 minutes for the OCXO to reach full stability, antenna adjustments may be performed by monitoring other signals, such as beacons.

Connect a spectrum analyzer to the RX IF output. Set the AnaSat®-C to the desired frequency using the RXCHAN (or RXFREQ) command, as described above. While monitoring the IF output for signals, slowly sweep the antenna through azimuth and elevation. Adjust antenna position for maximum signal strength.

Please note that the fan, on units so equipped, is thermostatically controlled and does not turn on when the unit is cold.

## M & C Operation

### Terminal Display

The M & C terminal display gives a complete accounting of transceiver alarms and status. The display is sent to the terminal every 30 seconds. This interval can be changed with the UTIMER command (See Appendix A).

The top line shows the transceiver model and serial number.

The second line gives the primary transceiver operating parameters:

- Status of the TXREQ setting: "ON" or "OFF"

"ON" indicates the transceiver will transmit when all major transmitter alarms are cleared. This is the normal setting.

"OFF" indicates the transmitter will not turn on even if all alarms are clear.

- Transmitter status is either "TX ON AIR" or "TX OFF AIR"

The third line gives a summary alarm indication. The alarm can be "CLEAR", "MINOR", or "MAJOR". See Appendix A for specific alarms.

The fourth and fifth lines give TX and RX channel (or frequency) and gain values.

- TXCHAN number is the actual transmit channel selected. Alternately, TXFREQ number is the actual transmit frequency for 70 MHz (140 MHz) input.
- TXGAIN is the actual transmit gain value selected in dB.
- RXCHAN number is the actual receive channel selected; or RXFREQ number is the actual receive frequency for 70 MHz (140 MHz) output.

- RXGAIN is the actual receiver gain value selected in dB.

The remainder of the display gives detailed monitoring information as follows:

- OSL LOCK gives alarm status of the OSL phase locked loop; NORMAL or FAULT
- TXLOCK gives alarm status of the transmit phase locked loop; NORMAL or FAULT
- RXLOCK gives alarm status of the receive phase locked loop; NORMAL or FAULT
- FANERR gives alarm status of the cooling fan (AnaSat-10C and AnaSat-20C only).
- OSLPLL shows the actual VCO control voltage of the offset loop.
- TXPLL shows the actual VCO control voltage of the TX synthesizer.
- RXPLL shows the actual VCO control voltage of the RX synthesizer.
- TEMP shows the internal heat sink temperature in °C.
- TXMUTE gives the status of the TX override circuits, any of which will turn off the transmitter.
- LNC shows the LNC supply voltage.
- XTAL gives the status of the internal reference crystal. The two possible statuses are WARMING or NORMAL. By default, WARMING will disable the transmitter.
- P12V shows the internal 13 volt power supply voltage.
- P5V shows the internal 5 volt power supply voltage.
- N5V shows the internal -5 volt power supply voltage.
- UTIMER gives the present value of the user timer which controls the cycle time of the display in seconds.
- TXin shows the approximate transmitter input (TX IF) power level in dBm.
- TXout shows the approximate transmitter output power level in dBm.
- TXpeak shows the recent (60 sec) peak transmitter output power level in dBm.
- RXout shows the approximate composite receiver output power level in dBm.
- TERMTYPE gives the present terminal type selection. Options are: “TTY”, “VT52”, and “VT100”.
- ECHO gives the present setting for the terminal echo function. When “ON”, the serial port will echo all characters typed. When this parameter is “OFF” then the port will not echo characters.
- CRLF gives the present setting for the serial port to issue a line feed (LF) after each carriage return (CR). Options are “ON” or “OFF”.
- BAUDRATE shows the present terminal communications speed setting in bits per second (bps).
- PA1 through PA6 gives the voltages for each stage of the transmitter power amplifier. Note that some low power models do not use all six voltages. As a special case, the 0dBm uses PA1 through PA6 to display up to six different status or voltage points on an external high power amplifier (HPA).

## Gain Adjustments

### *Transmitter Gain*

After the transceiver has warmed up for at least 5 minutes (OCXO warm-up) the transmitter may be activated. Set the transmit gain to achieve the desired output level (in dBm) with the transmit gain control, TXGAIN. Output power is selectable in 1 dB steps. Smaller steps can be entered, for example: TXG 62.5 and the M&C will attempt to provide that gain as close as possible.

Maintaining proper output power is vital for maximizing signal-to-noise ratios over the radio path. Low power levels produce noisy signals; excessive power robs downlink strength from other stations sharing the transponder.

Adjust the transmitter gain to attain the desired output power level. Use a calibrated watt meter for this task. The M&C gives an uncalibrated reading of output power which is good for long term monitoring, but it is not intended to replace a calibrated meter.

When transmitting multiple carriers, run the output power with an output back-off sufficient to meet the spectral density mask requirements.

**Caution:** It is recommended that the transmitter not be driven into saturation for long periods of time. The input power in dBm plus the requested TX gain in dB should not exceed the P1dB rating for the given transmitter.

TX input (dBm) + TX Gain (dBm) <= TX p1dB rating (dBm)

### *Receiver Gain*

Set receive gain by monitoring RX IF output level and adjust the RXGAIN parameter via the terminal. RXGAIN allow adjustment over a 15dB range, from 85dB to 100dB (including LNC gain), in 1 dB steps. Smaller step sizes can be entered, for example: RXG 87.5

Receiver gain should be set to a value where the desired receive signal is centered in the modem AGC range. At the same time, the composite signal, containing all received signals in the transceiver passband, must not exceed the modem's maximum rated input level. Account for IF cabling losses when calculating the RXGAIN value.

RX IF output is monitored by the M & C unit; a Summary alarm is generated if this output level drops below a specific level (generally when the LNC is not attached). The M & C uses an internal detector on the RX output to monitor RX output power. This is shown in the terminal display window in dBm. The RX output power value shown is not accurate enough to rely on for measuring the desired signal. The detector is broadband and will respond to ALL signals in the transponder, including noise.

Receiver gain setting is usually not as critical as transmit gain: excessive gain may cause modem receiver overloading and result in distortion on the received signal; insufficient gain presents reduced signal-to-noise ratios. Ideal RX gain puts the desired IF signal amplitude near the midpoint of the modem AGC range.

## *Basic M & C Commands*

1. Using the terminal, configure the transceiver to the proper frequency (see Appendix D):

RXCHAN nnn            nnn ranges from 1 to 501

TXCHAN nnn            nnn ranges from 1 to 501

2. Configure receive gain and transmit gain.

RXGAIN nnn            nnn ranges from 85 to 100 in 1 dB steps

TXGAIN nn            nn ranges from:

0 to 36 [0C]	60 to 86 [70C, 80C]
44 to 70 [2C]	61 to 87 [100C]
48 to 74 [5C]	62 to 88 [125C]
51 to 77 [10C]	63 to 89 [150C]
54 to 80 [20C]	64 to 90 [180C]
57 to 83 [30C, 40C]	64 to 90 [200C]
58 to 84 [50C, 60C]	

*NOTE: GAIN SETTINGS AND POWER READINGS ARE NOT INTENDED TO REPLACE A CALIBRATED POWER METER.*

Transmit gain is adjustable in 1 dB steps;  
to program 60 dB of gain, merely type:

```
TXGAIN 60 <cr>
```

For 60.5 dB of gain, type:

```
TXGAIN 60.5 <cr>
```

*NOTE: THE DECIMAL POINT IS ONLY NECESSARY WHEN 0.5dB OF GAIN RESOLUTION IS ATTEMPTED. FRACTIONAL VALUES MAY BE REQUESTED, BUT ONLY THE NEAREST WHOLE VALUE WILL BE DISPLAYED.*

3. Enable the Transmitter:

TX ON                    (TX OFF takes the transmitter OFF air)

## Maintenance

AnaSat<sup>®</sup> Transceivers are designed for a minimum of maintenance. Periodic scheduled maintenance is not required. Replacement of the weatherized fan after 7 years is recommended however.

### LNC Replacement

Although the AnaSat<sup>®</sup>-C family of transceivers is designed to need no normal maintenance, if it ever becomes necessary to replace the LNC, this procedure may be accomplished in the field with a minimum of equipment.

Two indications point to a faulty LNC; although a faulty LNC cable can also cause these symptoms.

- 1) Improper LNC Voltage
- 2) Receive IF output level low

Both of the above parameters are reported by the remote M & C terminal display.



*Transmitter RF output power levels are adequate to cause blindness or other serious injury to body tissues. Use caution when working around the Transceiver or antenna when the system is active.*

### ***LNC Replacement Procedure***

- 1) Remove power from the transceiver.
- 2) Disconnect the coax cable to the N-connector on the LNC.
- 3) Unbolt the LNC from the antenna mount. Save the weather tight gasket for reuse.
- 4) Attach the new LNC to the flange, using the gasket.
- 5) Reconnect the coax cable to the LNC N-connector.
- 6) Reapply power.
- 7) Verify receive gain with a known signal.

### ***Checking Receive Gain***

After the LNC is replaced, the system gain calibration may be affected. Check receive gain with a known signal.

- 1) Connect a satellite modem or a spectrum analyzer to the transceiver IF output (RXIF).
- 2) Monitor RXIF output from a known signal source (satellite or signal generator source).



- 3) Connect a terminal to the RS-232 or M & C ports on the transceiver. Using the command RXGAIN nnn (see Appendix A), adjust receive gain until the modem or spectrum analyzer shows an acceptable signal level.
- 4) If necessary, use the OFFSET\_RXG command for accurate receive gain correlation (see Appendix A for details).

## Fan Replacement



*The ducted fan shroud should NEVER be removed from the ODU while AC power is connected to the ODU. Disconnect AC power before replacing fan.*

Some units come with a weatherized fan and ducted fan shroud assembly that is attached to the PA heatsink, and is outside the transceiver enclosure. It is fairly easy to remove the shroud from the heatsink in order to replace the fan.



*Figure 9 - Fan shroud removed from AnaSat<sup>®</sup> transceiver*



*Figure 10 - Underside of AnaSat<sup>®</sup> Transceiver fan shroud*

The fan comes with a cable and three-prong connector. After the housing has been removed the heatsink, the old fan can be unplugged from the transceiver heatsink and then removed from the shroud. A replacement fan available from AnaCom, Inc., can then be mounted on the shroud and its connector plugged into the receptacle on the heatsink. The shroud can then be re-attached to the heatsink using the original screws.



*Figure 13 - Integrated fan and cable assembly*

## Alarm Relay Closure Option

If this option is installed, a mechanical relay is used in the transceiver for alarm indication. The red LED mounted on the transceiver is illuminated whenever a problem exists and the relay has closed.

The alarm relay has normally closed contacts, so it defaults to the alarm state when power is off.

### Monitored Values

The following internal points are monitored and can result in Alarm closure if out of range:

- PA temperature
- -5V DC supply (used as a bias voltage in the power amp stages)
- Each individual PA power supply
- Main +13V DC supply
- Synthesizer Lock detect
- Cooling fan failure (on units equipped with a fan)

### 18-Pin Circular Weathertight Connector

An 18-pin circular connector is used for monitoring the alarm C-Form relay. If the optional M&C serial port function is installed, see the AnaSat user manual for pin definitions and serial control commands.

Note dimple next to Pin 1

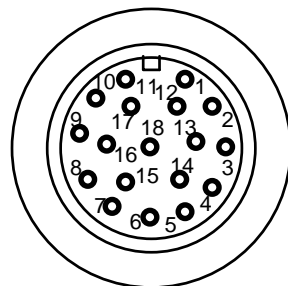

Cable End View

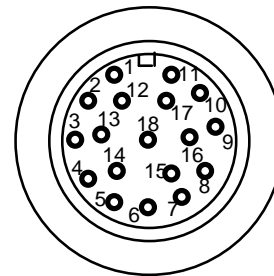

Cable Wire View

Pin	Signal	Description
4	NO	Alarm Normally Open
5	NC	Alarm Normally Closed
6	C	Alarm Common
7	P13V	+13VDC power (for PS)
8	TX+	RS485 or Ethernet TX+
9	TX-	RS485 or Ethernet TX-
10	RX+	RS485 RX+
11	RX-	RS485 RX-

Pin	Signal	Description
12	RS485*	(Ground to activate RS485)
13	Mute	(Ground to disable transmitter)
14	RX+	Ethernet RX+
15	RX-	Ethernet RX-
16	RXD	RS232
17	TXD	RS232
18	Ground	

\*If pin 12 is ungrounded, then Ethernet is active

The *Cable End View* refers to looking into the end of the connecting cable; the *Cable Wire View* refers to looking into the connector on the BUC.

## Appendix A. M & C Command Set

The transceiver will not respond to any command until a carriage return has been entered, terminating the command input. Multiple commands may be entered before a carriage return, using ";" as a delimiter.

Example:

```
TXCHAN 54; RXCHAN 36; SAVE
```

will set the transmit channel to 54, the receive channel to 36 and save these changes to a FLASH EEPROM. A transceiver response to user input can also be delimited in similar fashion.

If a command is not recognized, an error message is returned. For example, if "foo <cr>" is entered, the following is returned:

```
??????? foo
```

### Alphabetical Listing of M & C Commands

<u>Command</u>	<u>Page</u>
ALARMS .....	28
ALARM_MODE .....	29
BAUDRATE .....	29
CLEAR_PASSWORD .....	29
CLS.....	29
CRLF .....	29
DTE .....	29
DTE0 .....	29
DTE1 .....	29
ECHO .....	30
EXTREF .....	30
INFO.....	30
LABEL .....	30
LOCK PASSWORD .....	30
MODE .....	30
MODEM_MODE.....	30
MODEM_STRING .....	31
MSG .....	31
OFFSET .....	31
PC_MODE .....	31
PORT_TO_PORT .....	31
REFRESH .....	31
RESET.....	31
RXCHAN .....	31
RXGAIN .....	32
SAVE .....	32
SET_PASSWORD .....	32
TERMTYPE.....	32
TX.....	32
TXREQ.....	32
TXREQUEST.....	32

TXCHAN .....	32
TXFREQ .....	33
TXGAIN .....	33
UNLOCK PASSWORD .....	33
UTIMER .....	33
WARMUP .....	33
TXD; TXDAC .....	33
RXD; RXDAC .....	33

## ALARMS

This command returns a list of raised alarms for the given transceiver. The possible alarms are: WARMING, FANERR, OSLOCK, TXLOCK, RXLOCK, UCMUTE, PATEMP, TXOUT, P12V, PA, N5V, OSLPLL, TXPLL, RXPLL, P5V, LNCV, PROMERR and RXOUT.

If there are no alarms then "ALARMS CLEAR" is returned. Status of all individual alarms is evaluated ten times a second.

Alarms are categorized as **MAJOR** and **MINOR**, major alarms cause the external red LED on the transceiver to begin flashing. If there are no alarms, the status of the transceiver is CLEAR.

### MAJOR ALARMS

OSLOCK	raised when the OFFSET PLL has lost lock
TXLOCK	raised when the TX PLL has lost lock
RXLOCK	raised when the RX PLL has lost lock
UCMUTE	raised when the hardware mute circuit on the M & C board is active (this includes external TX shutdown)
PATEMP	when the heat sink temperature exceeds approx 85°C
PA	raised when any active power amplifier voltage drops too low
N5V	raised when the -5 volt supply drops too far
LNCV	raised when the LNC supply voltage drops too far
RXOUT	raised when the RX IF output power becomes too low
PROMERR	raised if a write or erase operation in the PROM fails

### MINOR

WARMING	when the warm-up software function is active upon reset or power cycling (power turn on)
FANERR	raised when fan current becomes too low (if a fan is installed)
TXOUT	raised when PA output is deemed by software to be too high
P12V	the primary 13V supply drops below a specified level
P5V	the 5V supply on the M & C board drops below a specified level
OSLOOP	OS VCXO voltage exceeds a specified range –may still be locked
TXLOOP	UC VCXO voltage exceeds a specified range –may still be locked
RXLOOP	DC VCXO voltage exceeds a specified range –may still be locked

There are alarm conditions which can shutdown the PA stage: WARMING and OSLOCK, TXLOCK, PATEMP, and N5V. When these alarms are active, the PA stage is shutdown via the supply lines which feed it. This may cause the PA alarm to be raised as well. The WARMUP alarm may be disabled with the WARMUP command.

**ALARM\_MODE [ NORMAL | PROTECTION ]**

There are two modes for alarm relay operation: Normal and Protection. In the NORMAL mode, the relays operate as MAJOR and MINOR relays as described above. In PROTECTION mode, the relays become redefined as TX and RX summary fault relays. The relay normally called MAJOR becomes the TX relay and the relay normally called MINOR becomes the RX relay.

In normal operation, the MAJOR relay is energized so that a power fault causes the relay to relax and thus provide an alarm contact closure. The MINOR relay is normally not energized (non-alarm state). During PROTECTION operation, both relays are normally energized (no alarms). Therefore, the RX relay has reverse definition of its contacts (NO and NC) for PROTECTION operation compared to its NORMAL operation.

**BAUDRATE [ 300 | 1200 | 2400 | 4800 | 9600 | 19200 | 38400 | 57600 ]**

This command sets the baudrate of the serial channel the user is presently connected to. Both serial ports have been programmed for 8 bits, no parity and 1 stop bit. These parameters are not user changeable.

**CLEAR\_PASSWORD PASSWORD**

This command will clear an existing password. Note that the password must be given in order for it to be cleared.

**CLS**

In terminal mode, 25 line feeds are sent to the terminal, effectively clearing the screen. In VT52 and VT100 modes, CLS refreshes the display.

**CRLF [ ON | OFF ]**

This command is only relevant to dumb-terminal mode. It sets (or returns) carriage-return/line-feed status. "CRLF ON" will command the M & C computer to insert a line-feed in display output following a carriage return. This can be necessary to make some terminal displays operate properly. In other cases this would be redundant.

**DTE****DTE0 [ COMMAND ]****DTE1 [ COMMAND ]**

These commands return a string of data regarding the specified serial port. If no port is specified then the present serial port is used.

Using DTE0 and DTE1 it is possible to change some of the serial port parameters for the serial port other than the one the operator is presently connected to. This could be especially useful for baud rate. Example of operator input from a terminal attached to serial port 0:

```
dtel baudrate 19200
```

The valid commands that can be used in this fashion for the opposing serial port are BAUDRATE, TERMTYPE, ECHO, CRLF, MODEM\_MODE, PC\_MODE, and TERMINAL\_MODE.

See the explanations for those commands elsewhere in this appendix.

**ECHO [ON | OFF]**

This command is only relevant in dumb-terminal mode. It sets (or returns) character echo mode. For example, if the operator is running a terminal emulation program on his PC with local echo disabled, type

ECHO ON

to enable echo back from the M & C computer. If the terminal is displaying doubled up characters, use ECHO OFF.

**EXTREF [ON | OFF]**

If ON, the ODU is programmed to accept an optional external 10MHz frequency reference source. If one is not present, a new alarm, EXTREF is raised. When an external reference signal appears while the EXTREF alarm is raised, the alarm will be dropped.

If OFF is given, then the internal source is used regardless of whether the optional reference source switch is indicating an external source is present or not.

The default setting is EXTREF OFF.

**INFO**

Returns information about software and hardware revision numbers.

**LABEL [TEXT]**

This command erases or [sets] an alphanumeric string up to 32 characters long that the user can use to “title” or describe the purpose of the given ODU.

**LOCK PASSWORD**

With this command most M & C functions will be locked and further user access will be denied until the UNLOCK command is given. Those commands that remain user accessible are: UNLOCK, CLS, ALARMS, and LIST.

If a password has been established with the SET\_PASSWORD command then that password must be used with the LOCK command. If there is no established password (if CLEAR\_PASSWORD has been used, for instance), then M & C functions will be locked; but they can be unlocked without a password. There are two solutions to the problem of having a locked unit and/or a forgotten password:

1. The unit can be reset using the internal DIP switches. See Appendix D.
2. If the unit is attached to a modem, and presently accessible remotely, telephone ANACOM.

**MODE**

This command returns either MODEM\_MODE or PC\_MODE. Example: MODE might return MODE MODEM\_MODE when the user is connected to the unit via a phone line and a Hayes compatible modem.

**MODEM\_MODE**

This command is used to tell the M & C computer that a Hayes compatible modem is attached to the serial port. The way this would be used is a user would enter this command from a PC using a null modem cable, then disconnect the PC and attach a modem directly to the port via a modem cable. RX, TX, DCD and signal GND lines must be properly connected.

Once MODEM\_MODE is activated, the M&C computer will no longer display dumb terminal display updates or generate packets in packet mode until the DATA-CARRIER\_DETECT line becomes active, indicating the modem is off-hook and connected to another modem.

**MODEM\_STRING [TEXT]**

When the M & C computer is in modem mode it will periodically send a Hayes compatible initialization string of up to 40 characters to the modem to make sure it is properly configured. The user can get [set] this string via this command. The default string as part of factory settings is:

```
MODEM_STRING AT S0=1 &C1 &S0 \Q0 E0
```

**MSG TEXT**

This command allows an operator connected to one serial port to send an ASCII message to someone connected to the other port. A message received will appear on the other operator's screen prefixed with the prompt MESSAGE>.

**OFFSET [TXGAIN | RXGAIN] [number]**

This command gets [sets] a floating point offset for TX or RX calibration tables. The valid arguments are: TXGAIN, RXGAIN.

The default value for these offsets is 0. Example usage:

```
OFFSET TXGAIN 2
```

The result of this is that the output would be 2 dB greater than what would otherwise be transmitted. In other words, the TX gain range would be shifted down by two decibels. If a TXGAIN of 72 dB were requested, the calibration data interpolation would be done internally with the value of 74 dB. If the user measures the TX gain with a power meter and finds that gain is high by 1.5 dB, then he might enter:

```
OFFSET TXGAIN -1.5
```

**PC\_MODE**

This is the converse of MODEM\_MODE. At any time, the user may type PC\_MODE and the M & C computer will again behave as if a PC or network is directly attached to the serial port rather than a modem.

**PORT\_TO\_PORT [ON|OFF]**

This command sets (gets) the status of the port\_to\_port function. When active on, then function re-transmits all serial port data from COM0 to COM1 and also from COM1 to COM0 regardless of data content. If the M & C interprets data as a legitimate command then the command is acted on. Otherwise the data is ignored by the M & C. When ON, the M & C does not issue ??????? when data is received which does not conform to a proper command.

WARNING: When this function is ON, the M & C will not automatically change baudrate to 1200 when the external data is changed to 1200.

**REFRESH**

This command refreshes the RF hardware to presently chosen receive and transmit channels and gain settings.

**RESET**

This command resets the M & C computer. Power-on time will reset to zero. Warning: RESET will shut down the transceiver momentarily.

**RXCHAN [number | INC | DEC]**

This command gets [sets] the receive channel number. See Appendix E for channel frequency information. *NOTE: Channel 0 is not a valid selection.*

---

**RXGAIN [number]**

This command gets [sets] receiver gain. The acceptable range is a two or three digit integer between 85 and 100 (dB).

**SAVE**

This command saves present M & C operating parameters to a FLASH EEPROM.

**SET\_PASSWORD PASSWORD PASSWORD**

The M & C computer supports password control of M & C functions. One potential use of this feature would be for leaving an ODU connected to a modem on an open telephone line. A valid password must be an alphanumeric string with no imbedded blanks, and between four and eight characters long inclusive. It must be given twice to ensure accuracy.

An existing password must first be cleared before setting a new password. This is done with the CLEAR\_PASSWORD command.

**TERMTYPE [TTY | VT52 | VT100] (OLD UNITS, OBSOLETE)**

This command is only relevant to dumb-terminal mode. It sets (or returns) the terminal emulation mode.

TTY Terminal Mode: this is a basic 80 character by 25 line ASCII “dumb” terminal mode.

VT52 Mode: This is a standard terminal emulation, more intelligent than TTY.

VT100 Mode: This is an enhanced communications terminal emulator with a fixed display window.

There are some control characters that will be filtered by the terminal driver when the M & C computer is in terminal mode. These control characters will be ignored in packet mode.

CTRL-E: This will erase the screen, similar to the CLS command.

CTRL-R: This repeats execution of the last Carriage return terminated command.

CTRL-Q: refer to the description of CTRL-S.

CTRL-S: Periodic screen updates will be squelched until the user has finished entering present command or hits CTRL-Q.

CTRL-BS: (Backspace) The present input command will be erased

**TX** [ON | OFF]

**TXREQ** [ON | OFF]

**TXREQUEST** [ON | OFF]

This command requests activation of the transmitter. This is done by enabling the PA supply voltages. TXREQ ON will indicate the operator’s desire to begin transmission. With no argument TXREQ simply return its present state as ON or OFF. Note that the unit will be shipped with TXREQ set to OFF.

Exactly when are we “ON AIR?” The answer is when TXREQ is ON, the hardware alarm TXMUTE is clear, and the transmitter is not software inhibited to allow the crystal reference oscillator time to warm-up at power-on. See the WARMUP command for details.

**TXCHAN [number]**

This command gets [sets] the transmit channel number. The acceptable range depends upon model type. See Appendix E for channel frequency information. *Channel 0 is not a valid selection.*



**TXFREQ [number]**

This command gets [sets] the transmit channel number. The acceptable range depends upon model type. The [number] is the actual transmit frequency output with TXIF at 70 MHz [or 140 MHz].

**TXGAIN [number | INC | DEC]**

This command gets [sets] or returns the transmit power amplifier gain. The acceptable range of the number is dependent upon model.

nn ranges from:

- 10 to 36 dB for the AnaSat 0C
- 44 to 70 dB for the AnaSat 2C
- 48 to 74 dB for the AnaSat 5C
- 51 to 77 dB for the AnaSat 10C
- 54 to 80 dB for the AnaSat 20C
- 57 to 83 dB for the AnaSat 30C, 40C
- 58 to 84 dB for the AnaSat 50C, 60C
- 60 to 86 dB for the AnaSat 70C, 80C
- 61 to 87 dB for the AnaSat 100C
- 62 to 88 dB for the AnaSat 125C
- 63 to 89 dB for the AnaSat 150C
- 64 to 90 dB for the AnaSat 180C
- 64 to 90 dB for the AnaSat 200C

**UNLOCK PASSWORD**

This command will unlock M & C functions for user access.

**UTIMER [NUMBER]**

This command is only relevant to dumb-terminal mode. It sets (or returns) the number of seconds between automatic display updates. Note that changing baud rate will automatically revert to a default appropriate for that particular baudrate.

**WARMUP [ON | OFF | CANCEL]**

Upon transceiver power-up, a 5 minute period will pass to allow the reference oscillator crystal oven sufficient warm up time. The unit is shipped with this flag set OFF, but can be changed by the user. Because there is no way for the M & C computer to know how long it has been off the air, a reset or momentary loss of power will cause a warm-up countdown to occur when the feature is in use. WARMUP CANCEL will terminate a warm-up countdown and immediately enable the transmitter.

**TXD; TXDAC [NUMBER]**

This command bypasses the transmit numerical gain compensation by the M&C. It will issue [number] 1 to 255 to the TX gain control element. This is for troubleshooting use only and transceiver should not be left in this mode, as the numerical compensation (temp. + freq.) would be disabled.

**RXD; RXDAC [NUMBER]**

This command bypasses the receive numerical gain compensation by the M&C. It will issue [number] 0 to 255 to the RX gain control element. This is for troubleshooting use only and transceiver should not be left in this mode, as the numerical compensation (temp. + freq.) would be disabled.

## Appendix B. ARM9 M&C Card Connection Methods

AnaSat<sup>®</sup> transceivers with the optional ARM9 M&C board support multiple connection methods, which are outlined below:

### Serial Port Methods

All of these methods can be used with AnaCom's Supervisor application, which can be downloaded from our website: [http://anacominc.com/prod\\_sw.html](http://anacominc.com/prod_sw.html).

#### **RS-232**

Available when the cable **P/N 31336** is used and plugged from the 18-pin connector on the transceiver chassis to a 9-pin serial port, or a USB to serial port adapter on the user's laptop/computer.

An ASCII terminal program is required to make use of a serial port connection; options are **Supervisor 10**, **RealTerm**, and **HyperTerminal**.

RealTerm can be downloaded from: <http://realterm.sourceforge.net/>.

**Typical usage:** a laptop connected to a single ODU through a short cable, 10' for setup purposes.

#### **RS-485**

Available when the cable **P/N 31415** is used. This cable contains an RS-485 to RS-232 converter, and plugs into a 9-pin connector on the user's computer or USB to serial port adapter.

AnaCom's Supervisor application or a third-party NMS is typically used with an RS-485 connection.

**Typical usage:** a laptop/computer connected to a single ODU or multiple ODUs and a protection switch through a long cable. Such a setup is often more permanent with the monitoring computer serving as part of the indoor installation.

#### **FSK**

This is a new method introduced with the ARM9 M&C card, and uses FSK signals on the TXIF cable. At present only the AnaCom packet protocol is supported using FSK, but we expect to support other protocols as requested and provided.

FSK runs at 9600 baud, and a circuit is required to take the signal off the TXIF line, and convert it to a standard such as RS-232. Supervisor works over FSK, provided there is an FSK to serial port converter. AnaCom will be able to provide that as an option in the near future.

## Ethernet-based Methods

All Ethernet-based methods of communication require cable **P/N 32999**. This cable has a weather-proof 18-pin connector on one end and a standard Ethernet connector on the other end. It is not possible to run both an RS-485 serial port connection and an Ethernet-based connection at the same time, as these two methods share pins in the connector. The connection method used by the ARM9 will switch automatically between RS-485 and Ethernet, depending on which cable has been plugged into it.

When an Ethernet cable is being used to connect a transceiver to a network, all Ethernet-based monitoring and control methods can be used at the same time. This includes Supervisor, a telnet session, a web browser monitoring the transceiver's web page, an SNMP device manager polling for status, etc.

Most Ethernet network traffic uses an IP protocol and therefore requires a device to have an IP address. AnaCom transceivers are shipped with a default address of 0.0.0.0. When a transceiver with this address is placed on a network, it will use the DHCP protocol to acquire an address from the local router.

There are some new commands that have been added to the M&C firmware to support IP-based communication:

### **DHCP [HELP | RENEW | ASSIGN]**

**HELP** Prints the following directions:

Manual DHCP process:

Step 1: send **DHCP RENEW** to start a DHCP request.

Wait about 10 seconds for this to complete.

Step 2: send **DHCP** to make sure a new IP address was acquired.

At this point, new address has **NOT** been used or saved.

Step 3: send **DHCP ASSIGN** to program the ODU to the new address.

Wait about 5 seconds, then connect on the new address.

### **IP\_ADDR [IP ADDRESS]**

#### **IP ADDRESS**

A specific IP address can be assigned manually if desired. With no argument, this command will print the present IP address being used by the transceiver. The address can also be reset to 0.0.0.0 using this command.

## Supervisor 10

Supervisor 10 can manage multiple serial port connections and ethernet connections at the same time. It is not necessary for transceivers to have IP addresses, nor is it necessary for there to be a DHCP server in order for Supervisor to find and manage any number of transceivers on the local network. A switch connecting all the transceivers together, with a computer running Supervisor 10, or a direct Ethernet cable running from a single transceiver to a computer is all that is necessary. Supervisor 10 implements a robust protocol for finding and managing however many transceivers are on the local network. Dashboard-type displays are generated for each transceiver it finds.

This software application can be downloaded from: [http://anacominc.com/prod\\_sw.html](http://anacominc.com/prod_sw.html).

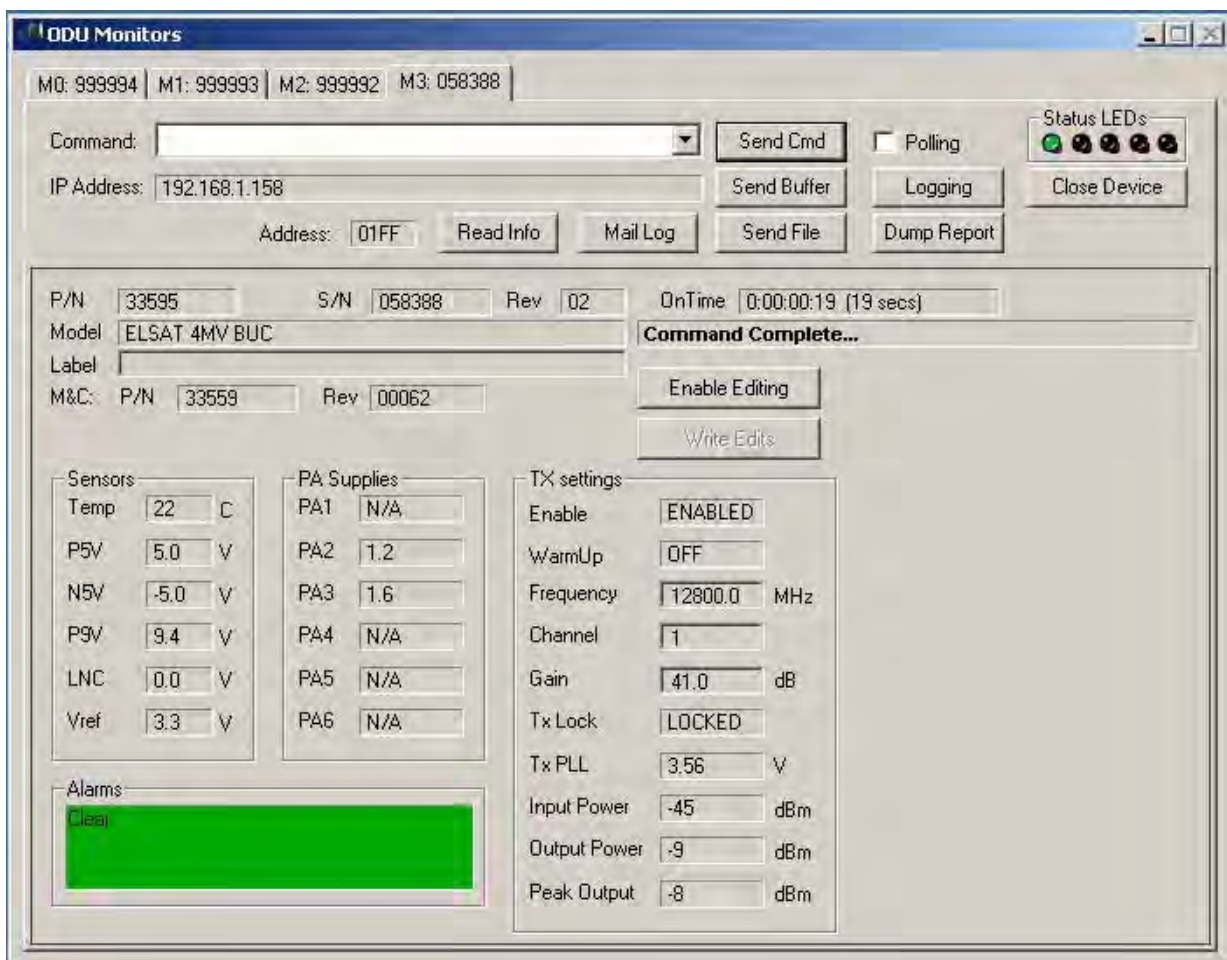

Example of Supervisor 10 monitoring transceivers

## *Telnet*

This is a terminal emulator method that works over Ethernet. Such a method can be used for initial setup, or to send commands while another method is be used to monitor the transceiver while unattended.

A good telnet program for Windows is PuTTY. More can be learned about it at <http://en.wikipedia.org/wiki/PuTTY>.

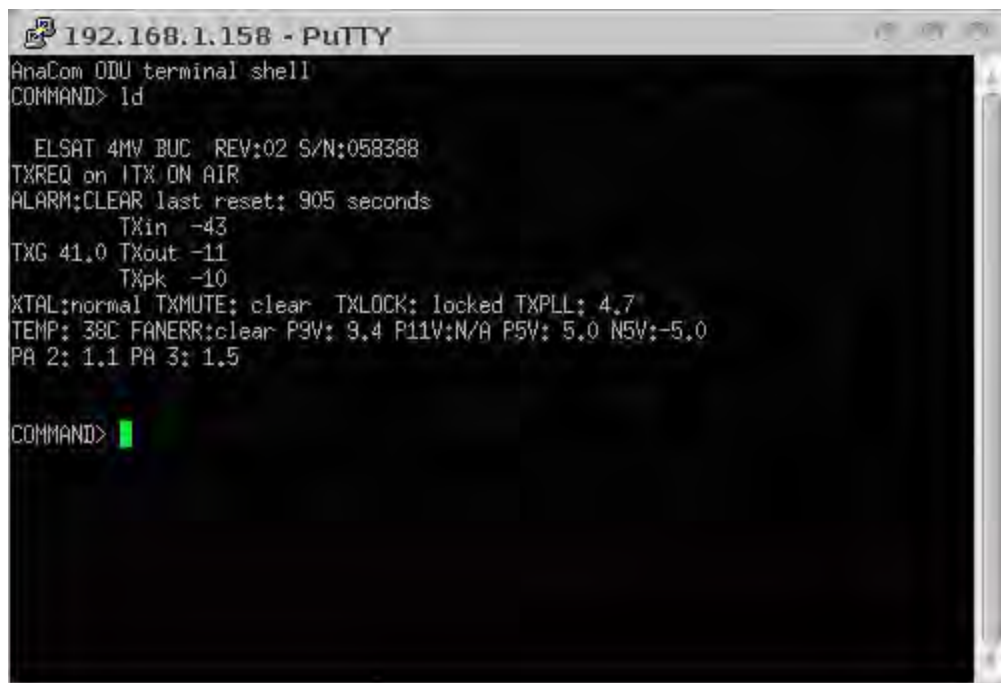

```
192.168.1.158 - PuTTY
AnaCom ODU terminal shell
COMMAND> id

  ELSAT 4MW BUC REV:02 S/N:058388
TXREQ on ITX DN AIR
ALARM:CLEAR last reset: 905 seconds
    TXin  -43
TXG 41.0 TXout -11
    TXpk  -10
XTAL:normal TXMUTE: clear TXLOCK: locked TXPLL: 4.7
TEMP: 38C FANERR:clear P3V: 9.4 P11V:N/A P5V: 5.0 N5V:-5.0
PA 2: 1.1 PA 3: 1.5

COMMAND> █
```

*Example of a telnet session using PuTTY*

## HTTP (web browser)

By entering a transceivers IP address into a browser's URL field (IE, Firefox, Chrome, and Opera have all been tested), the transceiver provides a web page that can be used to monitor and control its function. Once connected, the web page can be set to refresh periodically. Multiple browsers on different computers can be monitoring a transceiver's web page simultaneously. A browser can be used to monitor multiple transceivers by opening a separate browser tab for each transceiver.

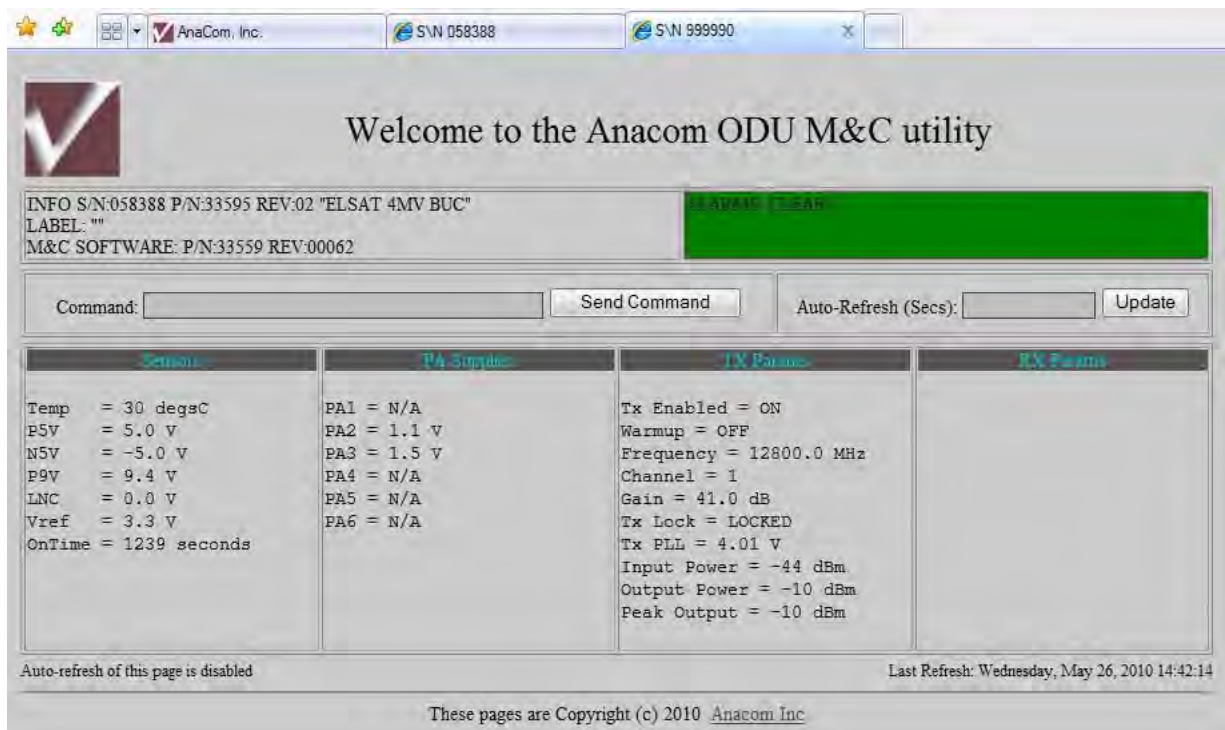

Example of Internet Explorer rendering the web page

## SNMP

Simple Network Management Protocol is an IP protocol used by NMS programs. It is a standardized means by which arbitrary devices from different vendors on a network can be monitored from a central location.

A simple demonstration application that shows the SNMP interface in operation can be downloaded from: [http://anacominc.com/prod\\_sw.html](http://anacominc.com/prod_sw.html). The file provided is a complete installer for Microsoft Windows.

In order for SNMP to work, a file called a MIB, (Management Information Base,) must be provided to the NMS software for each device type. This file is used to describe all the data that can be read out of a device and those parameters that can be written to, using SNMP.

AnaCom will provide a MIB for all devices that we support to any NMS vendor. The associated AnaCom OID is 1.3.6.1.4.1.4578.

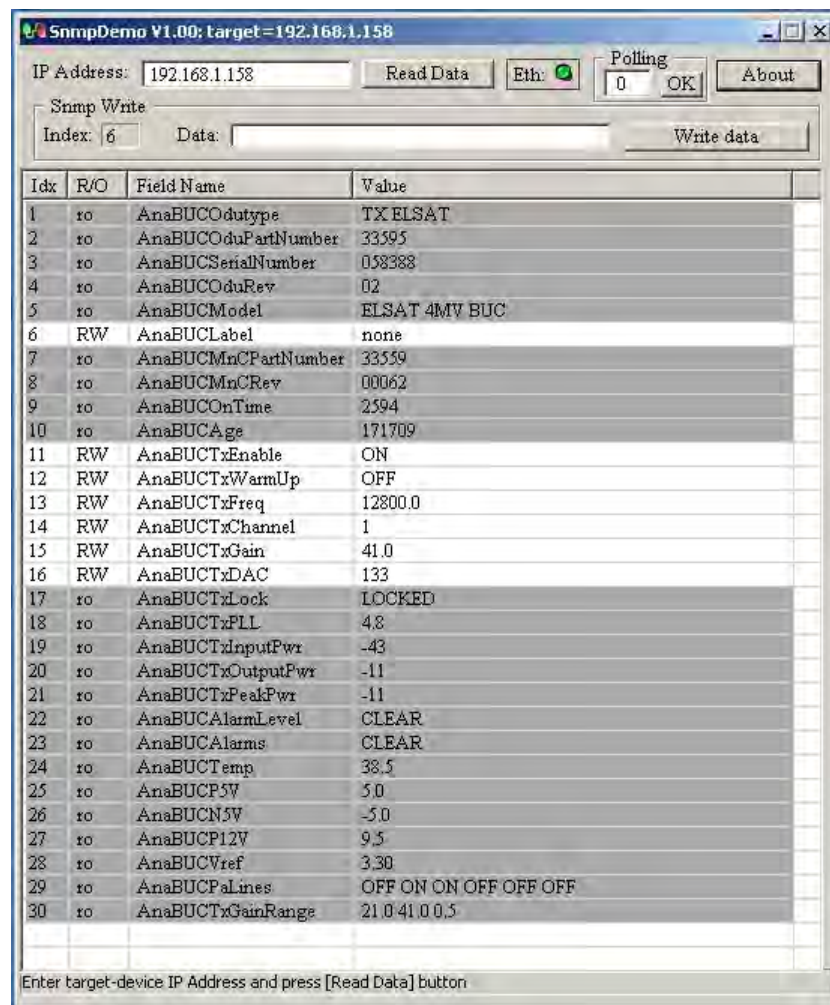

Example of using the SnmpDemo program to demonstrate the SNMP interface

## Appendix C. Serial Port Wiring

### COM1, 6-Pin Circular Weathertight Connector

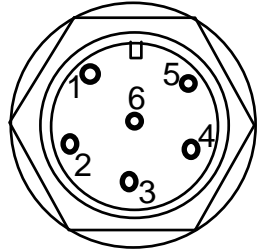

*Cable Wire View*

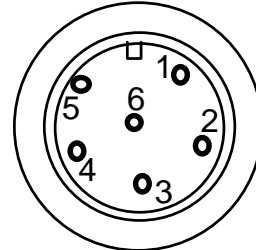

*Cable End View*

Pin	Signal	Description
1	DTR	Data Terminal Ready
2	DCD	Data Carrier Detect
3	DSR	Data Set Ready
4	RXD	Receive Data
5	TXD	Transmit Data
6	GND	Ground

Note dimple next to pin 1

### COM0, 18-Pin Circular Weathertight Connector

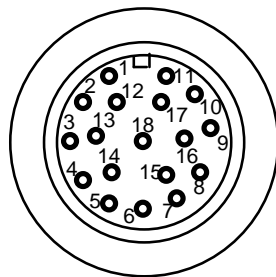

*Cable Wire View*

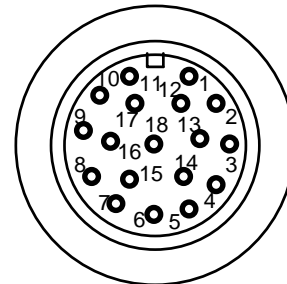

*Cable End View*

Pin	Signal	Description
1	RY1NO	Minor Alarm Normally Open
2	RY1NC	Minor Alarm Normally Close
3	RY1C	Minor Alarm Common
4	RY2NO	Major Alarm Normally Open
5	RY2NC	Major Alarm Normally Close
6	RY2C	Major Alarm Common
7	P13V	+13V DC Power
8	TX+	Differential Transmit Data
9	TX-	Differential Transmit Data

Pin	Signal	Description
10	RX+	Differential Receive Data
11	RX-	Differential Receive Data
12	RS485	RS485 Jumper (open for 232)
13	TXM	TX Mute*
14	DTR	Data Terminal Ready
15	DCD	Data Carrier Detect
16	RXD	Receive Data
17	TXD	Transmit Data
18	GND	Ground



## RS485/RS232 Selection

*(COM1, 18-Pin Connector Only)*

Pin 12 of the 18-pin Weathertight circular connector is the RS485/RS232 mode select pumper pin. Connect Pin 12 to Ground (Pin 18) for RS485 operation. Leave open for RS232 operation. This has no effect on the other serial port.

## Data Terminal Connection

Using a serial cable with a connector on one end that matches your terminal equipment (either a “dumb” terminal or a computer running terminal emulator or modem software), connect the 6-pin or 18-pin Weathertight circular connector to the other end, following Figure C-1 and the applicable previous table.

## Alternative Alarm Relay Wiring

For protected installations, it may be desired to operate the transceiver with the alarm relays reporting separate TX and RX alarms instead of the normal Major and Minor alarms. See Appendix A for the ALARM\_MODE command. When operating in PROTECTION mode, the alarm relays on the M&C connector should be wired per this chart:

Pin	Signal	Description
1	RY1NC	Minor Alarm Normally Close
2	RY1NO	Minor Alarm Normally Open
3	RY1C	Minor Alarm Common
4	RY2NO	Major Alarm Normally Open
5	RY2NC	Major Alarm Normally Close
6	RY2C	Major Alarm Common

**Note:** Only the first 6 pins of this 18 pin connector are shown. All other pins are as shown on the previous page.

25-Pin “D”	9-Pin “D”	SIGNAL	6-Pin circular	18-Pin circular
7 -----	5 -----	GROUND	6 -----	18
3 -----	2 ---	RX DATA--<--<--TX DATA	5 -----	17
2 -----	3 ---	TX DATA-->-->--RX DATA	4 -----	16
6 -----	6 -----	DSR	3 -----	--
8 -----	1 -----	DCD	2 -----	15
20 -----	4 -----	DTR	1 -----	14

**Note:** Select either the 9 or 25 pin female “D” connector to match your particular data terminal. Some terminals may not need the DTR, DSR, or DCD connections.

---

## Appendix D. Satellite Channel Listings

**EC-Band***For channels 1 to 501*

RX MHz = 3699+(channel)

**SEC Band***For channels -75 to -1*

RX MHz = 3700+(channel)

TX MHz = 5925+(channel)

*For channels 1 to 801*

RX MHz = 3699+(channel)

TX MHz = 5924+(channel)

**XC Band***For channels 1 to 601*

RX MHz = 4499.5+(channel/2)

TX MHz = 6724.5+(channel/2)

**PC Band***For channels 1 to 501*

RX MHz = 3499+(channel)

TX MHz = 6424+(channel)

**RC Band***For channels 1 to 501*

RX MHz = 3649+(channel)

TX MHz = 5974+(channel)

**LMC Band***For channels -75 to -1*

RX MHz = 3450+(channel)

TX MHz = 5775+(channel)

*For channels 1 to 501*

RX MHz = 3449+(channel)

TX MHz = 5774+(channel)

**Ku-Band***For channels 1 to 501*

TX MHz = 13999+(channel)

**EKU-Band***For channels -250 to -1*

TX MHz = 14000+(channel)

*For channels 1 to 251*

TX MHz = 13999+(channel)

**SEKU-Band***For channels -250 to -1*

TX MHz = 14000+(channel)

*For channels 1 to 501*

TX MHz = 13999+(channel)

**Ku-Band, EKU-Band, SEKU-Band***For channels 1 to 1801*

RX MHz = 10949+(channel)

## Appendix E. dBm/Watts Conversions

<u>dBm</u>	<u>W</u>	<u>dBm</u>	<u>W</u>
20	0.10	1	30.00
20.5	0.11	2	33.01
21	0.13	3	34.77
21.5	0.14	4	36.02
22	0.16	5	36.99
22.5	0.18	6	37.78
23	0.20	7	38.45
23.5	0.22	8	39.03
24	0.25	9	39.54
24.5	0.28	10	40.00
25	0.32	11	40.41
25.5	0.35	12	40.79
26	0.40	13	41.14
26.5	0.45	14	41.46
27	0.50	15	41.76
27.5	0.56	16	42.04
28	0.63	17	42.30
28.5	0.71	18	42.55
29	0.79	19	42.79
29.5	0.89	20	43.01
30	1.00	21	43.22
30.5	1.12	22	43.42
31	1.26	23	43.61
31.5	1.41	24	43.80
32	1.58	25	43.97
32.5	1.78	26	44.14
33	2.00	27	44.31
33.5	2.24	28	44.47
34	2.51	29	44.62
34.5	2.82	30	44.77
35	3.16	32	45.05
35.5	3.55	34	45.31
36	3.98	36	45.56
36.5	4.47	38	45.80
37	5.01	40	46.02
37.5	5.62	42	46.23
38	6.31	44	46.43
38.5	7.08	46	46.63
39	7.94	48	46.81
39.5	8.91	50	47.00
40	10.00	55	47.40
40.5	11.22	60	47.78
41	12.59	65	48.13
41.5	14.13	70	48.45
42	15.85	75	48.75
42.5	17.78	80	49.05
43	19.95	85	49.29
43.5	22.39	90	49.54
44	25.12	95	49.78
44.5	28.18	100	50.00

## LIMITED WARRANTY

If this product should fail due to defects in materials or workmanship, AnaCom, Inc., will, at its sole option, repair or replace it with new or rebuilt parts free of charge for a period of two (2) years from the date of shipment from the AnaCom factory. This warranty covers only failures due to defects in materials and workmanship that occurs during the period of the warranty. It does not cover damage that occurs during shipment, failure caused by operation of the product outside the published electrical or environmental specifications, or malfunctions caused by misuse of the product. Expendable components are not covered under this warranty.

In order for the customer to exercise their rights to repairs under the warranty, the customer must first contact AnaCom to obtain a repair authorization number (RMA). If it is necessary to return the product for repair, the customer is responsible for paying the cost of shipping it to AnaCom. AnaCom will pay the cost of shipping the product back to the customer when the repairs are completed. All import duties, customs fees, taxes of any kind, or any related fees are the sole responsibility of the customer.

Spare parts, repairs, or replacements are warranted to be free from defects in material or workmanship for ninety (90) days or the remainder of the limited warranty period, whichever is longer.

There are no express or implied warranties except as listed above. In no event shall AnaCom be liable for special, incidental, or consequential damages arising from the use of this product, or arising out of any breach of this warranty. All express and implied warranties, including the warranties of merchantability and fitness for a particular purpose, are limited to the applicable warranty period set forth above. No employee or representative of AnaCom is authorized to modify this warranty or AnaCom's standard warranty for any product.

Non-warranty repair service is available from AnaCom for a nominal charge. Non-warranty repair service can be obtained by contacting AnaCom and requesting a return authorization number (RMA), as described above. The customer is responsible for paying the cost of the shipping to and from AnaCom for any non-warranty repairs. Non-warranty repair service will be available for any AnaCom product for a minimum of five years from the date of its first shipment from AnaCom's factory.